

# LDO17520

## Low Power, Low Dropout, 500mA RF Linear Regulators

### FEATURES

- Low Dropout Voltage
- Thermal-Overload Protection
- Output Current Limit
- 10nA Logic-Controlled Shutdown
- 20 $\mu$ A Low Supply Current
- 1.7V to 7.5V Input Voltage Range
- 500mA Output Current
- -40°C to +85°C Operating Temperature Range
- Available in Green UTDFN-1x1-4, SOT23-5, SOT23-3, SOT353(SC70-5) and SOT89-3L (L-Type) Package

### APPLICATIONS

- Cellular Telephones
- Camera Modules
- Modems
- HiFi Audio Radio Transceivers
- PLL/Synthesizer, Clocking
- Medium-Current, Noise-Sensitive Applications

### DESCRIPTION

The LDO17520 series low-power, low-dropout, CMOS LDO operate from 1.7V to 7.5V input voltage that can supply up to 500 mA of output current. Designed to meet the requirements of RF and analog circuits, the LDO17520 series device provides low noise, high PSRR, low quiescent current, and low line and load transient response. The device is designed to work with a 1- $\mu$ F input and a 1- $\mu$ F output ceramic capacitor (no separate noise bypass capacitor required). An external noise bypass capacitor connected to the device's BP pin can further reduce the noise level.

Other features include a 10nA logic-controlled shutdown mode, foldback current limit and thermal shutdown protection.

The LDO17520 series is available in Green UTDFN-1x1-4, SOT23-3, SOT23-5, SOT353(SC70-5) and SOT89-3L(L-Type) package. It operates over an ambient temperature range of -40°C to +85°C.

### Functional Block Diagram

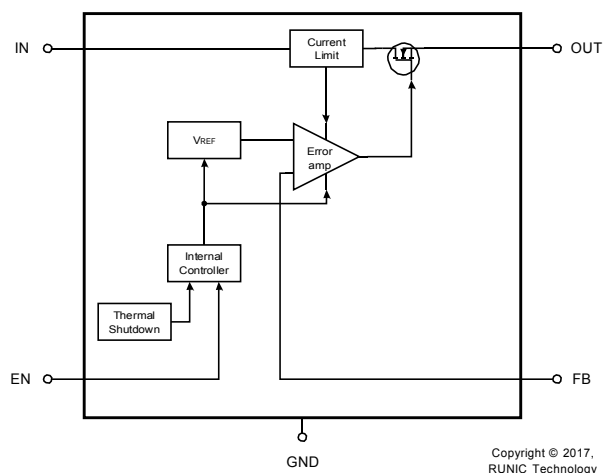
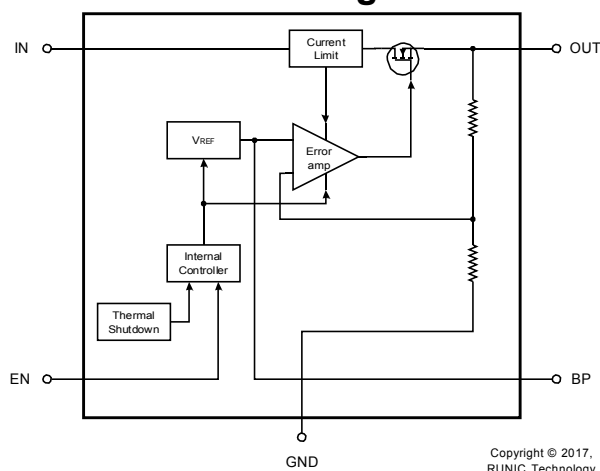

## Pin Configuration and Functions (Top View)

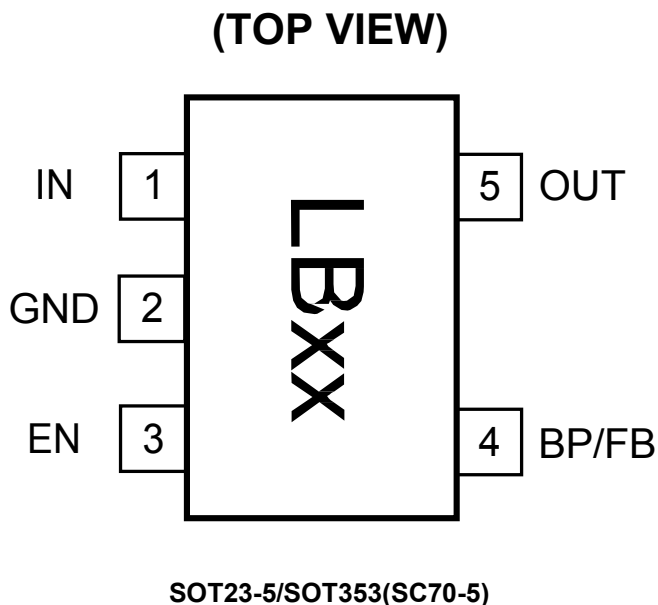
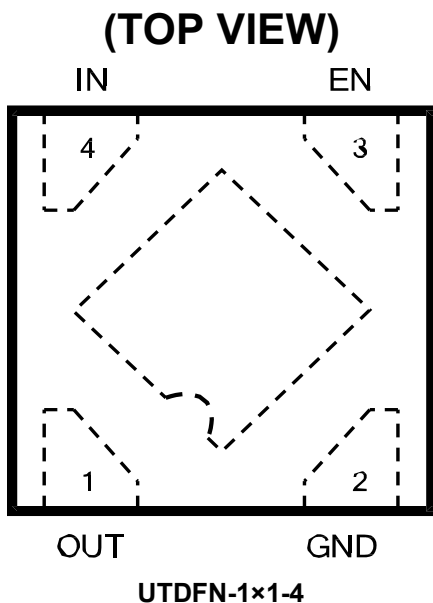

UTDFN-1x1-4		I/O	DESCRIPTION
NUMBER	NAME		
1	OUT	O	Regulator Output.
2	GND	G	Ground.
3	EN	I	Enable Input. A logic low reduces the supply current to 10nA. Connect to IN for normal operation.
4	IN	I	Regulator Input. Supply voltage can range from 1.7V to 7.5V. Bypass with a 1 $\mu$ F capacitor to GND.
Thermal Pad	-	-	Connect the thermal pad to a large-area ground plane. This pad is not an electrical connection to the device ground.

SOT23-5 /SOT353(SC70-5)		I/O	DESCRIPTION
NUMBER	NAME		
1	IN	I	Regulator Input. Supply voltage can range from 1.7V to 7.5V. Bypass with a 1 $\mu$ F capacitor to GND.
2	GND	G	Ground.
3	EN	I	Enable Input. A logic low reduces the supply current to 10nA. Connect to IN for normal operation.
4	BP	O	Reference-Noise Bypass (fixed voltage version only). Bypass with a low-leakage 0.01 $\mu$ F ceramic capacitor for reduced noise at the output. The capacitor is recommended to be placed very close to the pin for high PSRR.
	FB		Feedback Pin (adjustable voltage version only). This is used to set the output voltage of the device.
5	OUT	O	Regulator Output.

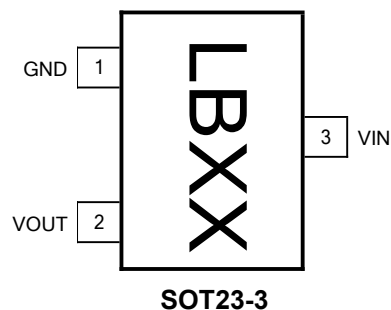
**(TOP VIEW)**

NOTE: XX indicate Output Voltage, xx indicate DataCode  
 For example: LB33 ( $V_{OUT}=3.3V$ )

<b>SOT23-3</b>		<b>I/O</b>	<b>DESCRIPTION</b>
<b>NUMBER</b>	<b>NAME</b>		
1	GND	G	Ground.
2	OUT	O	Regulator Output.
3	IN	I	Regulator Input. Supply voltage can range from 1.7V to 7.5V. Bypass with a 1 $\mu$ F capacitor to GND.

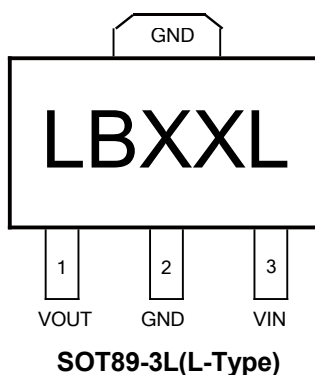

<b>SOT89-3L(L-Type)</b>		<b>I/O</b>	<b>DESCRIPTION</b>
<b>NUMBER</b>	<b>NAME</b>		
2	GND	G	Ground.
3	IN	I	Regulator Input. Supply voltage can range from 1.7V to 7.5V. Bypass with a 1 $\mu$ F capacitor to GND.
1	VOUT	O	Regulator Output.

## PACKAGE/ORDERING INFORMATION

MODEL	VOUT (V)	PIN-PACKAGE	ORDERING NUMBER	PACKAGE	PACKAGE OPTION
LDO17520-0.8	0.8V	UTDFN-1x1-4	LDO17520-	BA	Tape and Reel, 10000
LDO17520-1.0	1.0V	UTDFN-1x1-4	LDO17520-	BB	Tape and Reel, 10000
LDO17520-1.2	1.2V	UTDFN-1x1-4	LDO17520-	BC	Tape and Reel, 10000
LDO17520-1.5	1.5V	UTDFN-1x1-4	LDO17520-	BD	Tape and Reel, 10000
LDO17520-1.8	1.8V	UTDFN-1x1-4	LDO17520-	BE	Tape and Reel, 10000
LDO17520-2.05	2.05V	UTDFN-1x1-4	LDO17520-2.05YUTDN4	BF	Tape and Reel, 10000
LDO17520-2.5	2.5V	UTDFN-1x1-4	LDO17520-	BG	Tape and Reel, 10000
LDO17520-2.8	2.8V	UTDFN-1x1-4	LDO17520-	BH	Tape and Reel, 10000
LDO17520-3.0	3.0V	UTDFN-1x1-4	LDO17520-	BI	Tape and Reel, 10000
LDO17520-3.3	3.3V	UTDFN-1x1-4	LDO17520-	BJ	Tape and Reel, 10000
LDO17520-3.6	3.6V	UTDFN-1x1-4	LDO17520-	BK	Tape and Reel, 10000
LDO17520-4.0	4.0V	UTDFN-1x1-4	LDO17520-	BL	Tape and Reel, 10000
LDO17520-5.0	5.0V	UTDFN-1x1-4	LDO17520-	BM	Tape and Reel, 10000
LDO17520-0.8	0.8V	SOT23-5	LDO17520-0.8YF5	LB08	Tape and Reel, 3000
LDO17520-1.0	1.0V	SOT23-5	LDO17520-1.0YF5	LB10	Tape and Reel, 3000
LDO17520-1.2	1.2V	SOT23-5	LDO17520-1.2YF5	LB12	Tape and Reel, 3000
LDO17520-1.5	1.5V	SOT23-5	LDO17520-1.5YF5	LB15	Tape and Reel, 3000
LDO17520-1.8	1.8V	SOT23-5	LDO17520-1.8YF5	LB18	Tape and Reel, 3000
LDO17520-2.05	2.05V	SOT23-5	LDO17520-2.05YF5	LB205	Tape and Reel, 3000
LDO17520-2.5	2.5V	SOT23-5	LDO17520-2.5YF5	LB25	Tape and Reel, 3000
LDO17520-2.8	2.8V	SOT23-5	LDO17520-2.8YF5	LB28	Tape and Reel, 3000
LDO17520-3.0	3.0V	SOT23-5	LDO17520-3.0YF5	LB30	Tape and Reel, 3000
LDO17520-3.3	3.3V	SOT23-5	LDO17520-3.3YF5	LB33	Tape and Reel, 3000
LDO17520-3.6	3.6V	SOT23-5	LDO17520-3.6YF5	LB36	Tape and Reel, 3000
LDO17520-4.0	4.0V	SOT23-5	LDO17520-4.0YF5	LB40	Tape and Reel, 3000
LDO17520-5.0	5.0V	SOT23-5	LDO17520-5.0YF5	LB50	Tape and Reel, 3000
LDO17520-0.8	0.8V	SOT353(SC70-5)	LDO17520-0.8YC5	LB08	Tape and Reel, 3000
LDO17520-1.0	1.0V	SOT353(SC70-5)	LDO17520-1.0YC5	LB10	Tape and Reel, 3000
LDO17520-1.2	1.2V	SOT353(SC70-5)	LDO17520-1.2YC5	LB12	Tape and Reel, 3000
LDO17520-1.5	1.5V	SOT353(SC70-5)	LDO17520-1.5YC5	LB15	Tape and Reel, 3000
LDO17520-1.8	1.8V	SOT353(SC70-5)	LDO17520-1.8YC5	LB18	Tape and Reel, 3000
LDO17520-2.05	2.05V	SOT353(SC70-5)	LDO17520-2.05YC5	LB205	Tape and Reel, 3000
LDO17520-2.5	2.5V	SOT353(SC70-5)	LDO17520-2.5YC5	LB25	Tape and Reel, 3000
LDO17520-2.8	2.8V	SOT353(SC70-5)	LDO17520-2.8YC5	LB28	Tape and Reel, 3000
LDO17520-3.0	3.0V	SOT353(SC70-5)	LDO17520-3.0YC5	LB30	Tape and Reel, 3000
LDO17520-3.3	3.3V	SOT353(SC70-5)	LDO17520-3.3YC5	LB33	Tape and Reel, 3000
LDO17520-3.6	3.6V	SOT353(SC70-5)	LDO17520-3.6YC5	LB36	Tape and Reel, 3000
LDO17520-4.0	4.0V	SOT353(SC70-5)	LDO17520-4.0YC5	LB40	Tape and Reel, 3000
LDO17520-5.0	5.0V	SOT353(SC70-5)	LDO17520-5.0YC5	LB50	Tape and Reel, 3000

MODEL	VOUT (V)	PIN-PACKAGE	ORDERING NUMBER	PACKAGE	PACKAGE OPTION
LDO17520-1.35	1.35V	UTDFN-1x1-4	LDO17520-1.35YUTDN4	BN	Tape and Reel, 10000
LDO17520-1.85	1.85V	UTDFN-1x1-4	LDO17520-1.85YUTDN4	BO	Tape and Reel, 10000
LDO17520-3.3	3.3V	UTDFN-1x1-4	LDO17520-3.3AYUTDN4	BJ	Tape and Reel, 10000
LDO17520-2.7	2.7V	SOT23-5	LDO17520-2.7YF5	LB27	Tape and Reel, 3000
LDO17520-2.85	2.85V	SOT23-5	LDO17520-2.85YF5	LB285	Tape and Reel, 3000
LDO17520-0.8	0.8V	SOT23-3	LDO17520-0.8YF3	LB08	Tape and Reel, 3000
LDO17520-1.0	1.0V	SOT23-3	LDO17520-1.0YF3	LB10	Tape and Reel, 3000
LDO17520-1.2	1.2V	SOT23-3	LDO17520-1.2YF3	LB12	Tape and Reel, 3000
LDO17520-1.5	1.5V	SOT23-3	LDO17520-1.5YF3	LB15	Tape and Reel, 3000
LDO17520-1.8	1.8V	SOT23-3	LDO17520-1.8YF3	LB18	Tape and Reel, 3000
LDO17520-2.05	2.05V	SOT23-3	LDO17520-2.05YF3	LB205	Tape and Reel, 3000
LDO17520-2.5	2.5V	SOT23-3	LDO17520-2.5YF3	LB25	Tape and Reel, 3000
LDO17520-2.8	2.8V	SOT23-3	LDO17520-2.8YF3	LB28	Tape and Reel, 3000
LDO17520-3.0	3.0V	SOT23-3	LDO17520-3.0YF3	LB30	Tape and Reel, 3000
LDO17520-3.3	3.3V	SOT23-3	LDO17520-3.3YF3	LB33	Tape and Reel, 3000
LDO17520-3.6	3.6V	SOT23-3	LDO17520-3.6YF3	LB36	Tape and Reel, 3000
LDO17520-4.0	4.0V	SOT23-3	LDO17520-4.0YF3	LB40	Tape and Reel, 3000
LDO17520-5.0	5.0V	SOT23-3	LDO17520-5.0YF3	LB50	Tape and Reel, 3000
LDO17520-1.8	1.8V	SOT89-3L(L-Type)	LDO17520-1.8YE3L	LB18L	Tape and Reel, 1000
LDO17520-3.3	3.3V	SOT89-3L(L-Type)	LDO17520-3.3YE3L	LB33L	Tape and Reel, 1000

MODEL	V <sub>FB</sub> (V)	PIN-PACKAGE	ORDERING NUMBER	PACKAGE	PACKAGE OPTION
LDO17520-ADJ8	0.81	SOT23-5	LDO17520-	LBAD8	Tape and Reel, 3000
		SOT353(SC70-5)	LDO17520-	LBAD8	Tape and Reel, 3000
LDO17520-ADJC	1.21	SOT23-5	LDO17520-	LBADC	Tape and Reel, 3000
		SOT353(SC70-5)	LDO17520-	LBADC	Tape and Reel, 3000

## Absolute Maximum Ratings

over operating free-air temperature range (unless otherwise noted)<sup>(1)(2)</sup>

		MIN	MAX	UNIT
V <sub>IN</sub>	Input voltage	-0.3	8	V
V <sub>EN</sub>	Enable input voltage	-0.3	V <sub>IN</sub>	V
T <sub>J</sub>	Junction temperature		150	°C
P <sub>D</sub>	Continuous power dissipation <sup>(3)</sup>	Internally Limited		W
T <sub>stg</sub>	Storage temperature	-65	150	°C

- (1) Stresses beyond those listed under *Absolute Maximum Ratings* may cause permanent damage to the device. These are stress ratings only, and functional operation of the device at these or any other conditions beyond those indicated under *Recommended Operating Conditions* is not implied. Exposure to absolute-maximum-rated conditions for extended periods may affect device reliability.
- (2) All voltages are with respect to the GND pin.
- (3) Internal thermal shutdown circuitry protects the device from permanent damage.

## ESD Ratings

		VALUE	UNIT	
V <sub>(ESD)</sub>	Electrostatic discharge	Human-body model (HBM)	±6000	V
		Machine model (MM)	±400	V

## Recommended Operating Conditions

over operating free-air temperature range (unless otherwise noted)<sup>(1)</sup>

		MIN	MAX	UNIT
V <sub>IN</sub>	Input supply voltage	1.7	7.5	V
V <sub>EN</sub>	Enable input voltage	0	V <sub>IN</sub>	V
I <sub>OUT</sub>	Output current	0	500	mA
T <sub>J</sub>	Junction temperature	-40	+85	°C

- (1) All voltages are with respect to the GND pin.

## Thermal Information

THERMAL METRIC (1)		LDO1752	LDO17520	LDO17520	LDO17520	LDO17520	UNIT
		ŪTDFN-1x1-4	SOT353 (SC70-5)	SOT23-5	SOT23-3	SOT89-3L (L-Type)	
		4 PINS	5 PINS	5 PINS	3 PINS	3 PINS	
R <sub>θJA</sub>	Junction-to-ambient thermal resistance	144.1	268	185.6	185.6	165	°C/W
R <sub>θJC(top)</sub>	Junction-to-case (top) thermal resistance	137.9	171.8	104.3	104.3	88.5	°C/W
R <sub>θJB</sub>	Junction-to-board thermal resistance	83.5	64.5	54.5	54.5	39.6	°C/W
ψ <sub>JT</sub>	Junction-to-top characterization parameter	5.3	40.5	31.0	31.0	26.5	°C/W
ψ <sub>JB</sub>	Junction-to-board characterization parameter	83.8	62.9	54.5	54.5	49.7	°C/W
R <sub>JC(bot)</sub>	Junction-to-case (bottom) thermal resistance	71.8	N/A	N/A	N/A	77.7	°C/W

**ELECTRICAL CHARACTERISTICS**

( $V_{IN} = V_{OUT (NOMINAL)} + 0.5V$  <sup>(1)</sup>, Full = -40°C to +85°C, unless otherwise noted.)

PARAMETER	SYMBOL	CONDITIONS	TEMP	MIN	TYP	MAX	UNITS
Input Voltage	$V_{IN}$		+25°C	1.7 <sup>(1)</sup>		7.5	V
Output Voltage Accuracy <sup>(1)</sup>		$I_{OUT} = 0.1mA$	+25°C	-2.5		2.5	%
		$I_{OUT} = 0.1mA$ , LDO17520-3.3AYUTDN4	+25°C	-1		1	%
Feedback Voltage	$V_{FB}$	$I_{OUT} = 0.1 mA$ , LDO17520-ADJ8	+25°C	0.79	0.81	0.83	V
		$I_{OUT} = 0.1 mA$ , LDO17520-ADJC	+25°C	1.18	1.21	1.24	V
Maximum Output Current <sup>(1)</sup>			+25°C	500			mA
Current Limit <sup>(1)</sup>	$I_{LIM}$		+25°C	500	800		mA
Ground Pin Current	$I_Q$	No load	+25°C		15	20	$\mu A$
Dropout Voltage <sup>(2)</sup>	$V_{DROP}$	$I_{OUT} = 500mA$	+25°C	$V_{OUT}=1.2V$		900	mV
				$V_{OUT}=1.5V$		630	
				$V_{OUT}=3.3V$		450	
Line Regulation <sup>(1)</sup>	$\Delta V_{LNR}$	$V_{IN} = (V_{OUT} + 0.5V)$ to 7.5V, $I_{OUT} = 1mA$	+25°C		0.1	0.2	%/V
Load Regulation	$\Delta V_{OUT}$	$I_{OUT} = 0.1mA$ to 500mA, $C_{OUT} = 1\mu F$ ,	+25°C		25	50	mV
Output Voltage Noise	$e_n$	$f = 10Hz$ to 100kHz, $C_{BP} = 0.01\mu F$ , $C_{OUT} = 10\mu F$ , $I_{OUT} = 30mA$	+25°C		80		$\mu V_{RMS}$
Output Voltage Temperature Coefficient	$\frac{\Delta V_{OUT}}{\Delta T_A \times V_{OUT}}$	$I_{LOAD} = 0.1mA$	FULL		35		ppm/°C
Power Supply Rejection Ratio	PSRR	$C_{BP} = 0\mu F$ , $I_{LOAD} = 30mA$ , $C_{OUT} = 1\mu F$ , $V_{IN} = V_{OUT} + 1V$ $\Delta V_{RIPPLE} = 0.2V_{P-P}$	$f = 217Hz$	+25°C		72	dB
			$f = 1kHz$			70	
		$C_{BP} = 10nF$ , $I_{LOAD} = 30mA$ , $C_{OUT} = 1\mu F$ , $V_{IN} = V_{OUT} + 1V$ $\Delta V_{RIPPLE} = 0.2V_{P-P}$	$f = 217Hz$	+25°C		74	dB
			$f = 1kHz$			70	
<b>SHUTDOWN</b>							
EN Input Threshold	$V_{IH}$	$V_{IN} = 1.7V$		Full	1.4		V
	$V_{IL}$						
EN Input Threshold	$V_{IH}$	$V_{IN} = 7.5V$		Full	2.3		V
	$V_{IL}$						
EN Input Bias Current	$I_{BH}$	$EN = 7.5V$	+25°C		0.01	1	$\mu A$
	$I_{BL}$	$EN = 0V$	Full		0.01		
Shutdown Supply Current	$I_{Q(SHDN)}$	$EN = 0V$	Full		0.01	1	$\mu A$
Start-Up Time <sup>(4)</sup>	$t_{STR}$	$C_{OUT} = 1\mu F$ , No Load	+25°C		180		$\mu s$
<b>THERMAL PROTECTION</b>							
Thermal Shutdown Temperature	$T_{SHDN}$				140		°C

NOTES:

- $V_{IN} = V_{OUT (NOMINAL)} + 0.5V$  or 1.7V, whichever is greater.
- The dropout voltage is defined as  $V_{IN} - V_{OUT}$ , when  $V_{OUT}$  is 100mV below the value of  $V_{OUT}$  for  $V_{IN} = V_{OUT} + 0.5V$ .
- Time needed for  $V_{OUT}$  to reach 90% of final value.

TYPICAL APPLICATION CIRCUIT

<p style="text-align: center;">Typical Circuit</p> <p style="text-align: center;">SOT23-5/SOT353(SC70-5)</p>	<p style="text-align: center;">Typical Circuit</p> <p style="text-align: center;">UTDFN-1x1-4</p>
<p style="text-align: center;">Typical Circuit</p> <p style="text-align: center;">SOT23-5/SOT353(SC70-5)</p>	<p style="text-align: center;">Typical Circuit</p> <p style="text-align: center;">SOT23-5/SOT353(SC70-5)</p>
<p>NOTE: Choose <math>R_2 = 160k\Omega</math> to maintain a <math>5\mu A</math> minimum load. Calculate the value for <math>R_1</math> using the following equation:</p> $R_1 = R_2 * \left( \frac{V_{OUT}}{0.81} - 1 \right)$	<p>NOTE: Choose <math>R_2 = 240k\Omega</math> to maintain a <math>5\mu A</math> minimum load. Calculate the value for <math>R_1</math> using the following equation:</p> $R_1 = R_2 * \left( \frac{V_{OUT}}{1.21} - 1 \right)$



## TYPICAL PERFORMANCE CHARACTERISTICS

$V_{IN} = V_{OUT (NOMINAL)} + 0.5V$ ,  $C_{IN} = 1\mu F$ ,  $C_{OUT} = 1\mu F$ ,  $C_{BP} = 0\mu F$ ,  $T_A = +25^\circ C$ , unless otherwise noted.

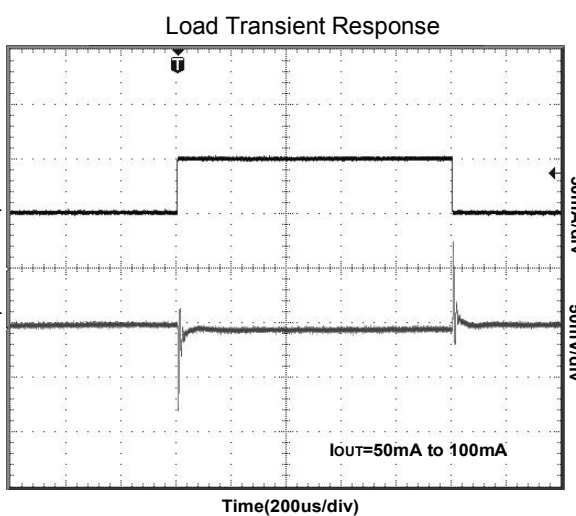
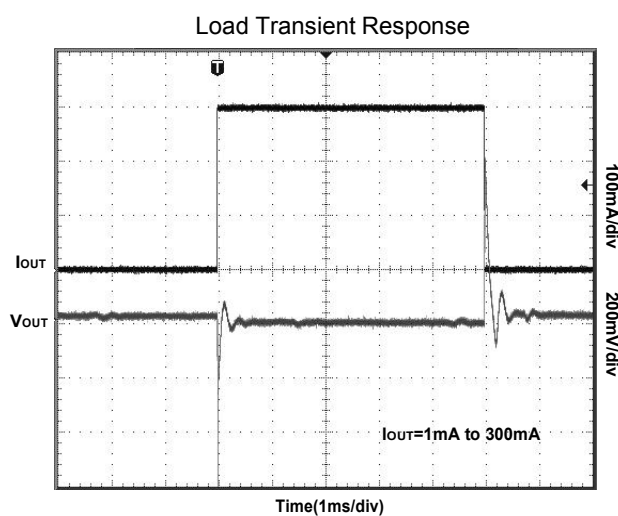
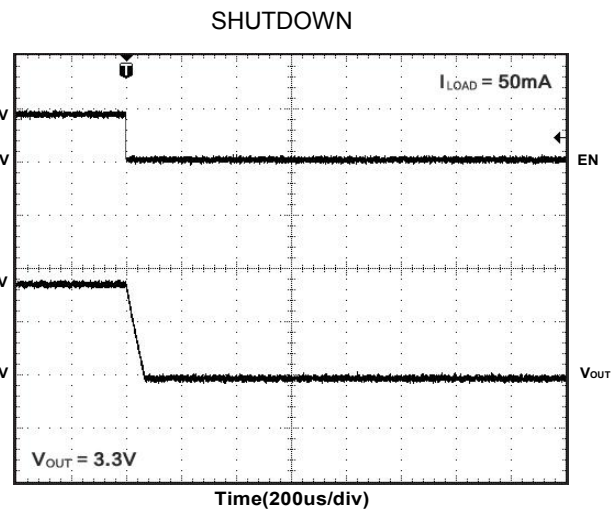
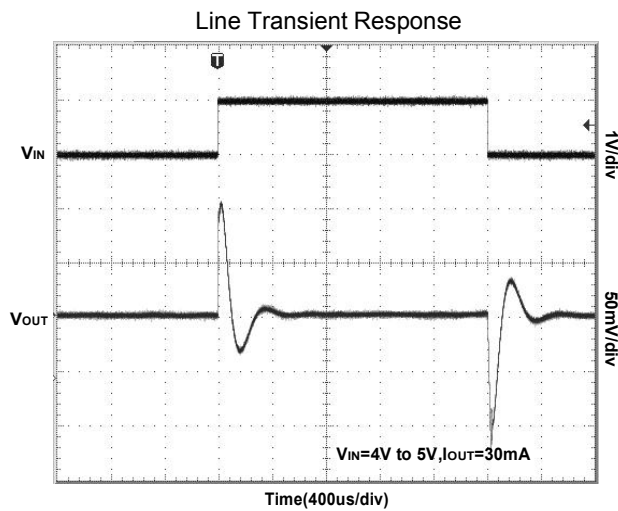
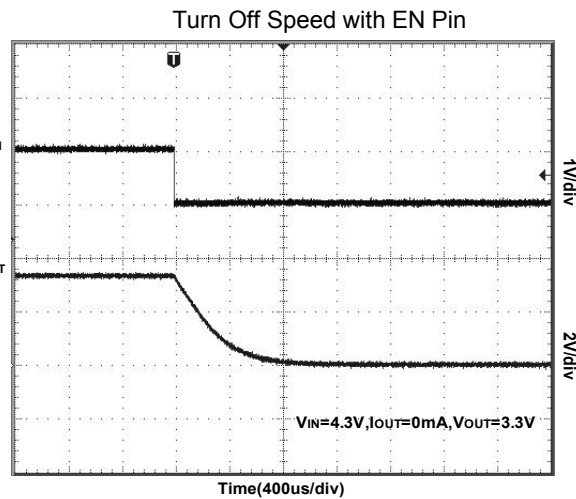
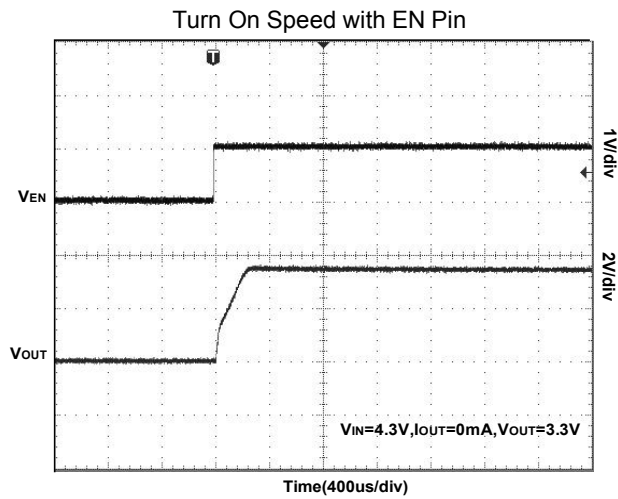

## TYPICAL PERFORMANCE CHARACTERISTICS

$V_{IN} = V_{OUT (NOMINAL)} + 0.5V$ ,  $C_{IN} = 1\mu F$ ,  $C_{OUT} = 1\mu F$ ,  $C_{BP} = 0.1\mu F$ ,  $T_A = +25^\circ C$ , unless otherwise noted.

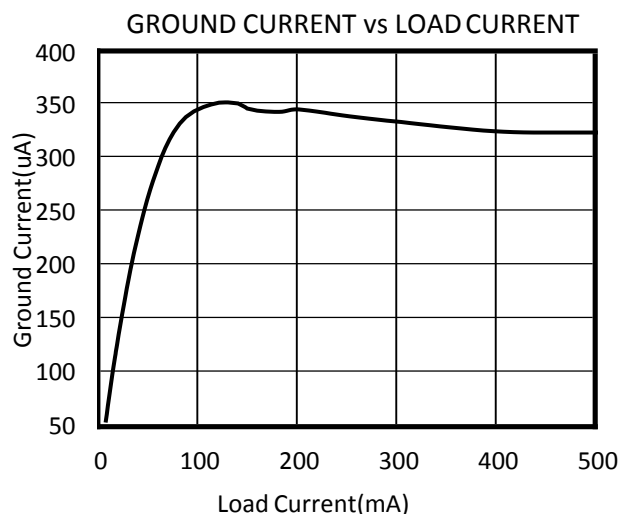
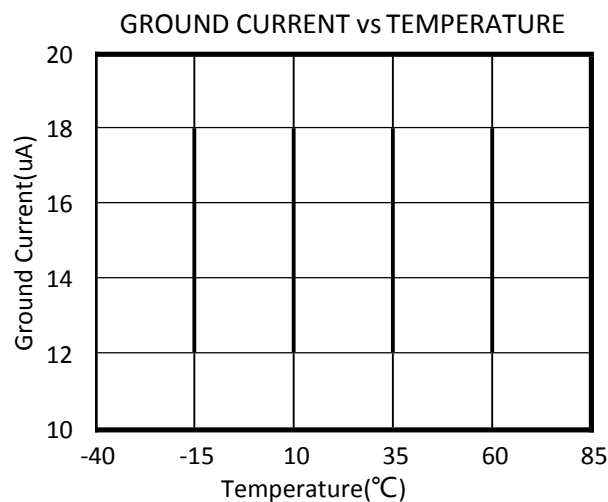
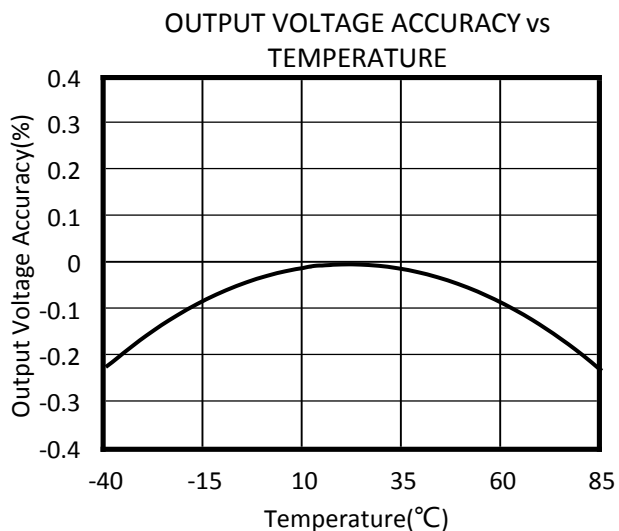
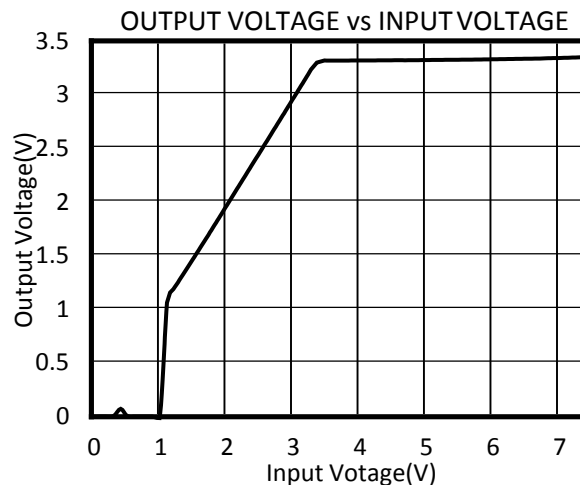
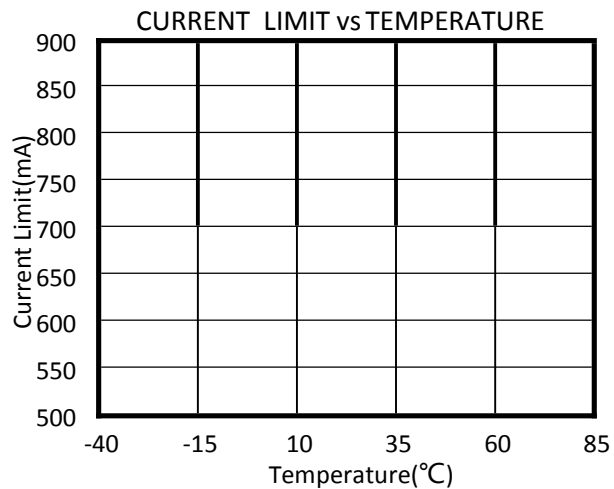

## PACKAGE OUTLINE DIMENSIONS

# SOT23-3

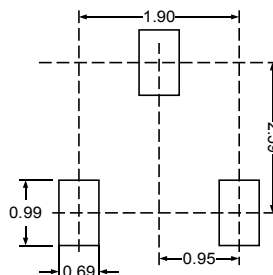
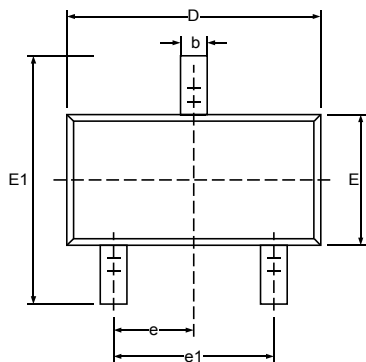

RECOMMENDED LAND PATTERN (Unit: mm)

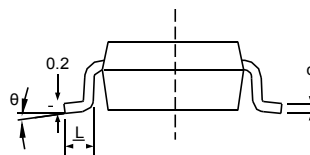
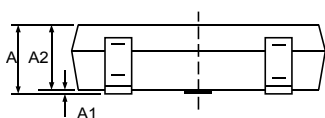

Symbol	Dimensions In Millimeters		Dimensions In Inches	
	Min	Max	Min	Max
A	1.050	1.250	0.041	0.049
A1	0.000	0.100	0.000	0.004
A2	1.050	1.150	0.041	0.045
b	0.300	0.500	0.012	0.020
c	0.100	0.200	0.004	0.008
D	2.820	3.020	0.111	0.119
E	1.500	1.700	0.059	0.067
E1	2.650	2.950	0.104	0.116
e	0.950(BSC)		0.037(BSC)	
e1	1.800	2.000	0.071	0.079
L	0.300	0.600	0.012	0.024
$\theta$	0°	8°	0°	8°

## SOT23-5

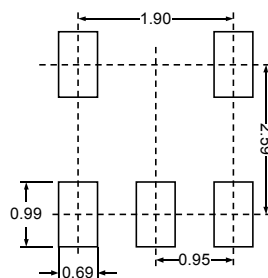
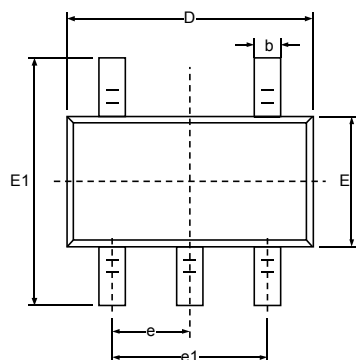

RECOMMENDED LAND PATTERN (Unit: mm)

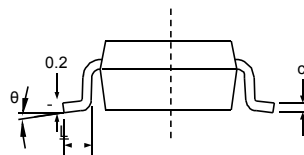
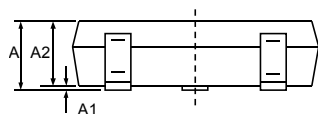

Symbol	Dimensions In Millimeters		Dimensions In Inches	
	Min	Max	Min	Max
A	1.050	1.250	0.041	0.049
A1	0.000	0.100	0.000	0.004
A2	1.050	1.150	0.041	0.045
b	0.300	0.500	0.012	0.020
c	0.100	0.200	0.004	0.008
D	2.820	3.020	0.111	0.119
E	1.500	1.700	0.059	0.067
E1	2.650	2.950	0.104	0.116
e	0.950(BSC)		0.037(BSC)	
e1	1.800	2.000	0.071	0.079
L	0.300	0.600	0.012	0.024
$\theta$	0°	8°	0°	8°

# SOT353(SC70-5)

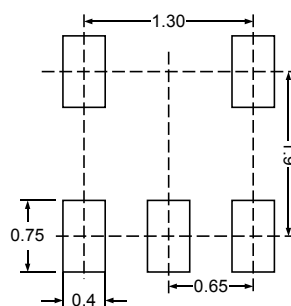
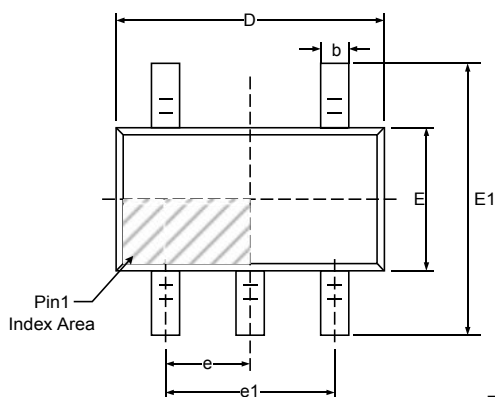

RECOMMENDED LAND PATTERN (Unit: mm)

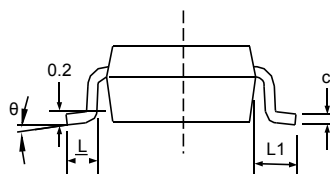
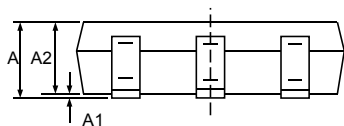

Symbol	Dimensions In Millimeters		Dimensions In Inches	
	Min	Max	Min	Max
A	0.900	1.100	0.035	0.043
A1	0.000	0.100	0.000	0.004
A2	0.900	1.000	0.035	0.039
b	0.150	0.350	0.006	0.014
c	0.080	0.150	0.003	0.006
D	2.000	2.200	0.079	0.087
E	1.150	1.350	0.045	0.053
E1	2.150	2.450	0.085	0.096
e	0.650(BSC)		0.026(BSC)	
e1	1.300(BSC)		0.051(BSC)	
L	0.260	0.460	0.010	0.018
L1	0.525		0.021	
θ	0°	8°	0°	8°

# UTDFN-1x1-4

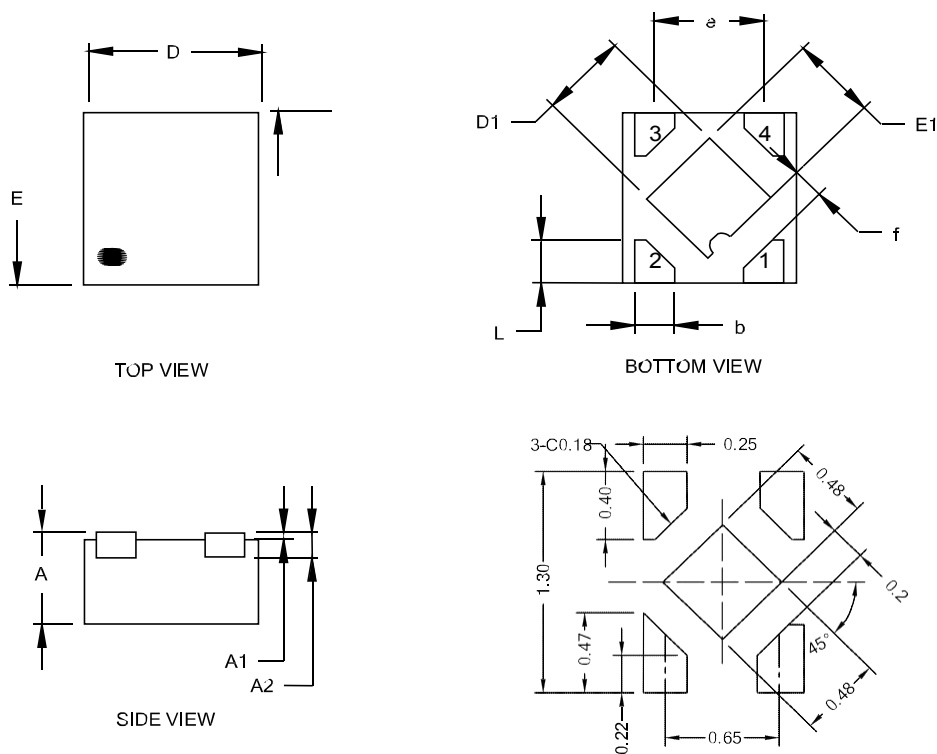

RECOMMENDED LAND PATTERN (Unit: mm)

Symbol	Dimensions In Millimeters		
	MIN	MOD	MAX
A	0.340	0.370	0.400
A1	0.000	0.020	0.050
A2	0.100REF		
D	0.950	1.000	1.050
D1	0.430	0.480	0.530
E	0.950	1.000	1.050
E1	0.430	0.480	0.530
b	0.170	0.220	0.270
e	0.600	0.650	0.700
f	0.195REF		
L	0.200	0.250	0.300

## SOT89-3L

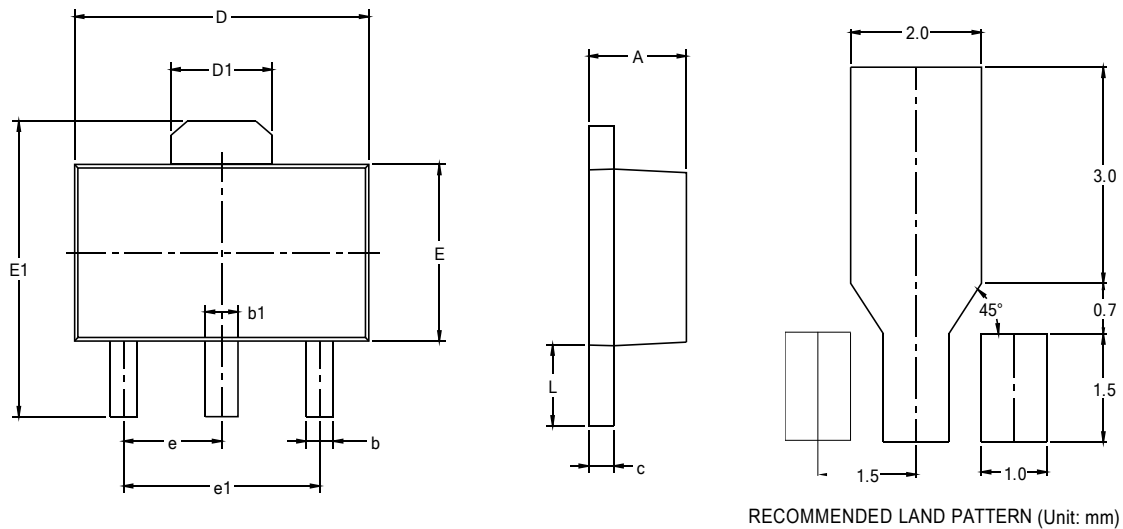

Symbol	Dimensions In Millimeters		Dimensions In Inches	
	Min	Max	Min	Max
A	1.400	1.600	0.055	0.063
b	0.320	0.520	0.013	0.020
b1	0.400	0.580	0.016	0.023
c	0.350	0.440	0.014	0.017
D	4.400	4.600	0.173	0.181
D1	1.550 REF		0.061 REF	
E	2.300	2.600	0.091	0.102
E1	3.940	4.250	0.155	0.167
e	1.500 BSC		0.060 BSC	
e1	3.000 BSC		0.118 BSC	
L	0.900	1.200	0.035	0.047